

**LED pool light Remote Control  
with built in transformer**

# **OWNER'S MANUAL**

## PL-REM-60



**Spectra**vision™  
lighting

**Controls Spectravision Pool Lights**

## Table of contents

Technical specifications	Page 3
Box contents	Page 4
Installation instructions	Page 5
Pairing Handheld Transmitter & controller	Page 6
Handheld transmitter functions	Page 7
Replacing transmitter battery	Page 7
Troubleshooting	Page 7

## Technical specifications

### Electrical specifications

Nominal Input voltage	230 VAC 50 Hz
Output voltage on Lamp Output	12 VAC
Max output current on Lamp Output	5A
Transformer VA rating	60VA
Frequency band transmitter	433 MHz

### General specifications Controller

Ambient air temperature	0°C ... +40°C
Humidity	10% ... 90% RH non condensing
Dimensions	150x157x51 mm
Weight	1,3 kg
Ingress Protection Rate	IP54

## Box contents

1. PL-REM-60 controller
2. Handheld transmitter
3. Spare battery
4. Screws (4x) & wall plugs (4x)
5. Owner's Manual

1

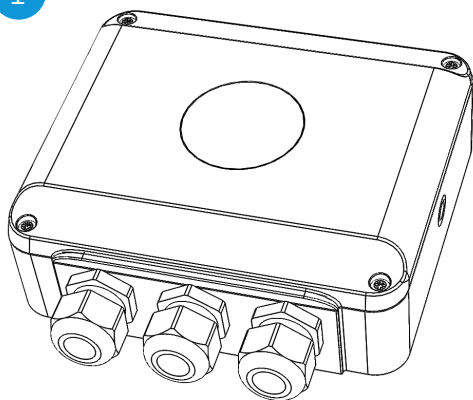

2



3



4

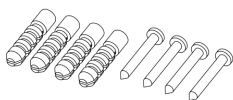

5

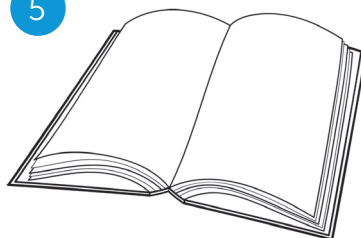

**Spectra**vision™  
lighting

## Installation instructions

- Connect a 230VAC power source to the “220-240VAC INPUT” terminal.
- Connect the swimming pool lights to the “Lamp 12VAC output” terminal

 Make sure the total load of pool lights does not exceed 60Watt

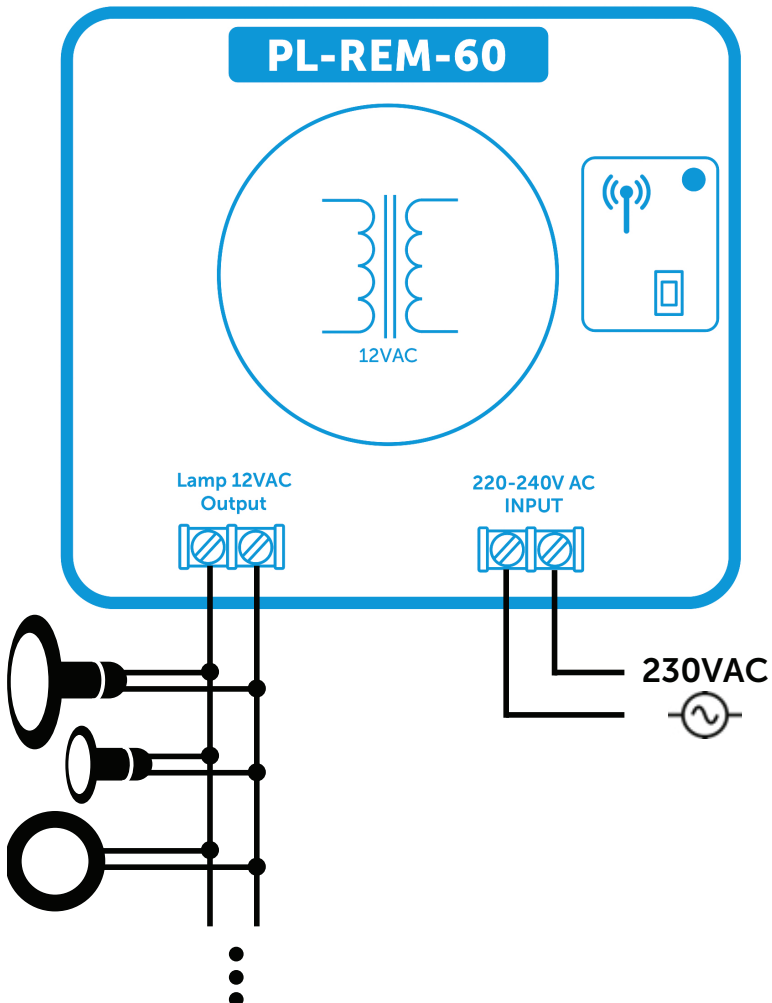

## Pairing handheld transmitter & controller

The handheld transmitter is already paired in the factory and ready to use. In case a problem arises, the pairing process can be done as below:

*Manual Pairing process:*

Make sure the PL-REM-60 is connected to a power source.

1. Press (and release) the Pairing button on the small circuit board, inside the controller (the button is close to the antenna).
2. Press the COLOR button on the transmitter (and release).
3. Press the ON/OFF button on the transmitter (and release).

If the transmitter is paired correctly, the red LED on the small circuit board will light up, every time a button is pushed on the handheld transmitter.

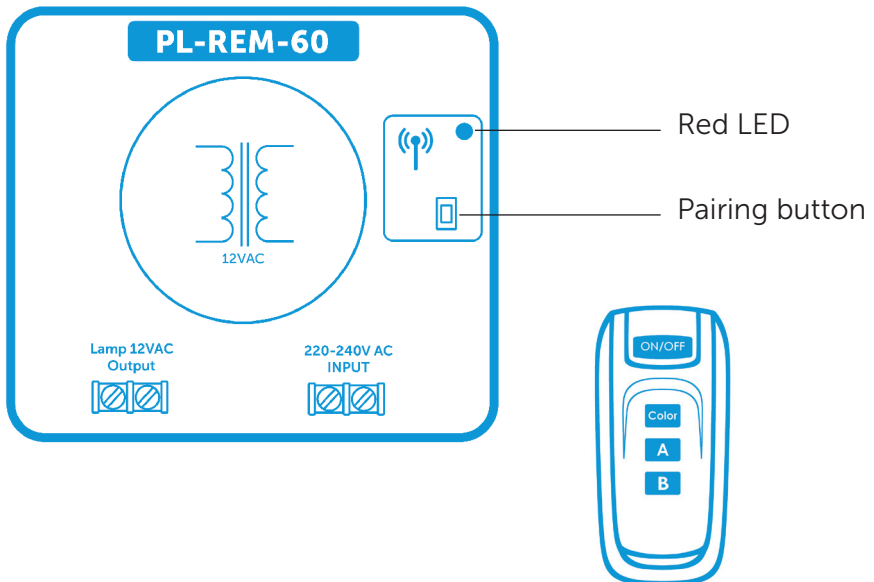

**Spectra**vision™  
lighting

## Handheld transmitter functions

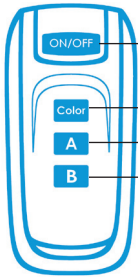

- Toggle the lamps ON/OFF
- Go to next color scenario
- Button A and B have no function with PL-REM-60

## Replacing transmitter battery

- Remove the philips head screw and open the transmitter
  - Replace the battery, respecting the polarity
- Battery type: A23 12V

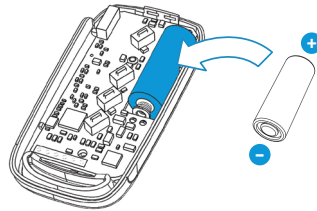
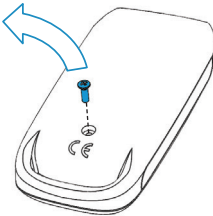

## Troubleshooting

### PROBLEM

The controller doesn't react to transmitter commands

### SOLUTION

- Check the battery of the handheld transmitter
  - Check if the antenna of the transmitter is pulled out
  - The transmitter is not paired correctly with the controller. Repeat the pairing process
  - Reduce the distance between handheld transmitter and PL-REM-60 and/or eliminate obstacles
- 
- Check if there is 12VAC output at the terminals of the controller

The pool lights don't work

## Contact details

### Propulsion Systems bvba

Dooren 72  
1785 Merchtem, Belgium

Tel +32 2 461 02 53

Fax +32 2 706 59 60

[www.propulsionsystems.be](http://www.propulsionsystems.be)

[info@propulsionsystems.be](mailto:info@propulsionsystems.be)



**Spectra**vision™  
lighting

